



Parameterizable Temperature Measuring Transducer

MU 1.00 GW

FEATURES

- **Input:**
PT 100, NI 1000, PTC, KTY, thermocouples, poti 0...5 kΩ, other sensors via software
- **Output: 0(4)...20 mA / 0(2)...10 V**
- **2 relays, function selectable**
- **Detection of sensor break and short-circuit**
- **Redundant measurement at thermocouples possible**
- **Int./ext. cold-junction compensation**
- **Parameterization without auxiliary power via PC-interface**
- **Galvanic 3-way isolation of 4 kV**

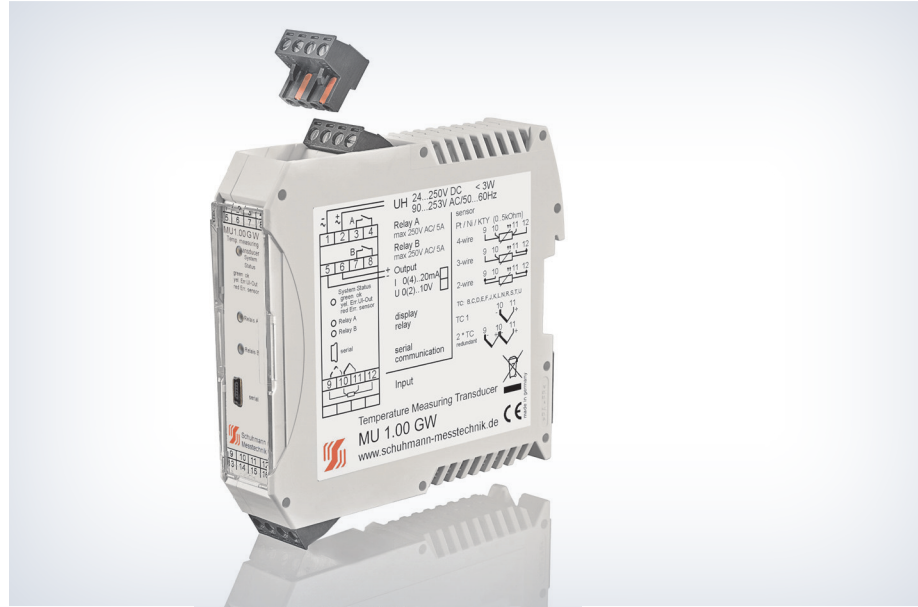

FUNCTION

The MU 1.00 GW is processing sensor signals and is used for the precise measurement of virtually all temperature sensors. Measurements of temperatures within a range of -200 and +2400 °C can be made, for example in air-conditioning and process engineering. Sensor break and sensor short-circuit are signaled and can be used as safety functions. By PT-sensors different connections can be selected: 2-, 3-, 4-wire system. The measuring line of the 3- or 4-wire connection is detected on wire break or short-circuits.

Further temperature sensor cams can be produced by a table of value and assigned to the transducer by the USB2 Interface in connection with KALIB-Software. Higher functional safety offers the redundant connection of thermocouples to the transducer. Indication of status is signaled by a front sided LED. The integrated protective switching with suppressor diode protects the secondary circuit from voltage peaks and transient excess voltage. 2 relays for error evaluation, limit value monitoring and tendency function are available. Switching status of the relays are signaled by LEDs on front side.

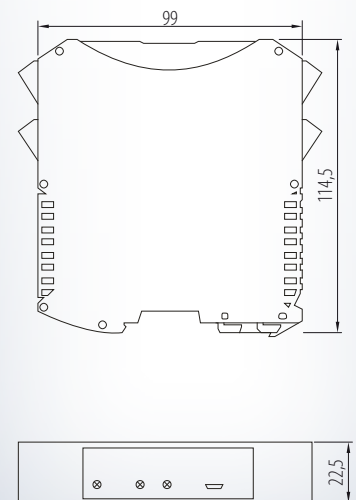
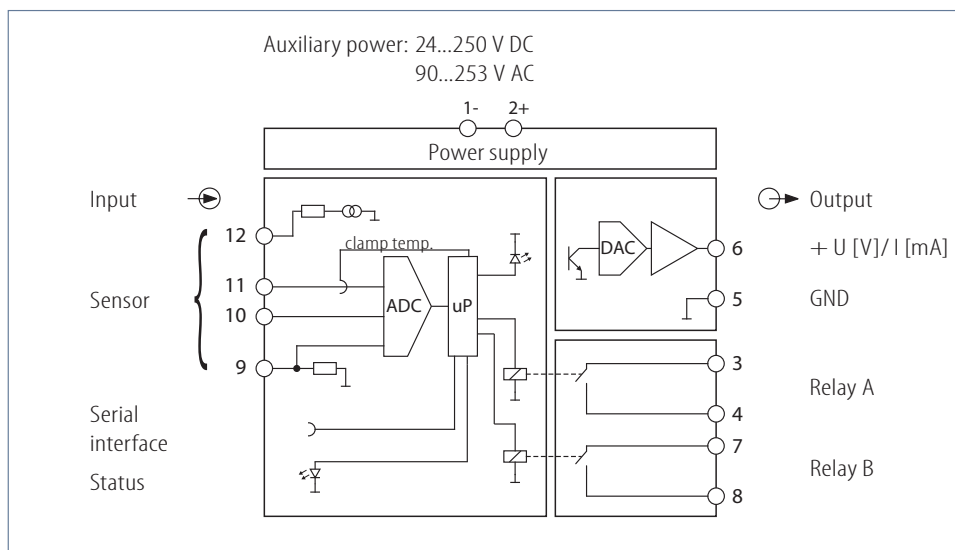

MU 1.00 GW

Connection diagram:

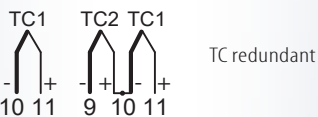
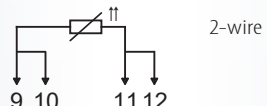
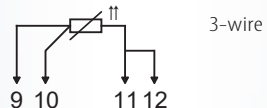
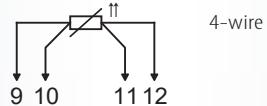
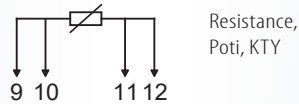
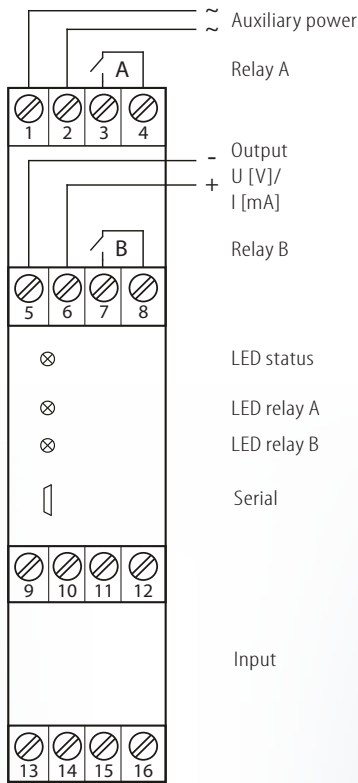

Schuhmann GmbH & Co. KG
 Römerstraße 2
 D-74363 Güglingen
 Tel. +49 71 35 50 56
 Fax +49 71 35 53 55
 www.schuhmann-messtechnik.de

Input:

Sensor	Measurement range	Additional temperature sensor cams can be created by using KALIB-Software.
Type B	400...1820 °C	Temperature compensation: - internal: ± 1 K typ., max $\pm 1,2$ K - external: at high temperature thermocouples recommended
Type C	400...2300 °C	
Type D	400...2400 °C	
Type E	-200...1000 °C	
Type J	-200...1200 °C	
Type K	-200...1372 °C	
Type L	-200...900 °C	
Type N	-200...1300 °C	
Type R	-50...1760 °C	
Type S	-50...1760 °C	
Type T	-200...400 °C	Redundancy at thermocouples: - thermocouple TC1 has priority over TC2 - at deviation TC1 to TC2 > 30 °C warning via LED
Type U	-200...400 °C	
KTY 81-110., KTY 82-122..		
KTY 83-110., KT 100/110/130		
KT 210/230, KTY 10/11/13-5..		
KTY 21/23-5..	-58...150 °C	
PTC		
PT 100, PT 500, PT 1000	-200...850 °C	
NI 100, NI 500, NI 1000	-58...208 °C	
Poti (2-wire) User	0...500 Ω / 5 k Ω	

Input resistance:	approx. 1 M Ω at thermocouples
Sampling cycle:	approx. 100 ms int.
limiting frequency:	approx. 0,5 Hz
connection:	terminal 5, 6, 7, 8 PT- 2/3/4 wire, at 2-wire measurement with offset correction

Output:

I: load-independent DC current:	0(4)...20 mA	permissible load max. 680 Ω
connection:	terminal 3 -, 4 +	
U: load-independent DC voltage:	0(2)...10 V	permissible load ≥ 2 k Ω
connection:	terminal 3 -, 4 +	
Relay A/ B:	1 NO contact per relay	
max. switching current/ -voltage:	6 A / 250 V AC	
Mechanical/ contact lifetime:	30 x 10 ⁶ cycles / 10 ⁵ cycles	

Adjustment:

Measuring ranges and parameterization are adjustable by KALIB-Software. For this you need a PC as well as the interface adapter **USB2/ USB-Simulator** with **KALIB-Software**.

Display:

LED status	green, active yellow, active red, active	input signals are in standard range, device ready for use failure output signal, warning message failure e.g. sensor break, short-circuit, sensor failure
LED relay A:	green, active	relay A is closed
LED relay B:	green, active	relay B is closed

Environmental conditions:

Storage temperature:	-40...+70 °C
Operating temperature:	0...55 °C
Isolation voltage:	4 kV eff. 1 sec. input-output 4 kV eff. 1 sec. auxiliary voltage

Auxiliary power:

Wide range:	24...250 V DC 90...253 V AC < 3 W
-------------	---

Influence of auxiliary power:	< 0,1 %
-------------------------------	---------

Characteristics of transmission:

Transmission error:	< 0,12 %
Resolution:	0,1 °C, 16 bit
Linearity error:	< 0,03 %
Temperature error:	< 30 ppm/ K
Load influence I:	< 0,07 % of final value
Load influence U:	< 0,15 % at 2 k Ω load

Directive:

EMC Directive:	2014/30/EU*
Low Voltage Directive:	2014/35/EU
*minimum deviations possible during HF-radiation influence	

Mounting details:

Housing for top hat rail	
Type of protection:	IP 40 housing IP 20 clamps
Mounting rail fixed according to	EN 50022-35 x 6,2 mm
Width:	22,5 mm
Weight:	180 g
Material:	Polyamide PA
Flammability class:	V0 (UL 94)
Approval:	CE
Connection:	plugg. screw clamps $\leq 2,5$ mm ²

Please check parameterization before initial operation!

Ordering information:

Type: MU 1.00 GW wide range
 Accessories: USB2/ USB-Simulator with KALIB-Software

03.07.2019